

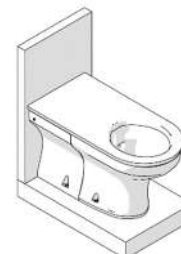

Wallgate Anti-Ligature, A/V Disable S/Surface BTW Pan S&P w/ Grey Integral Seat With Front Brackets



PRODUCT CODES:

- CWC-156FF-STJ-AM
- CWC-156FF-STW-AM

1. Disclaimer

Every effort has been made to supply information within this manual which is correct. Galvin Engineering Pty Ltd and Wallgate Limited will not be liable for any damage or loss that arises if the person installing, operating, or maintaining the unit has not read or not complied with the manual.

In any event, and without prejudice to any warranties in Galvin Engineering and Wallgate Limited's terms and conditions of sale, Galvin Engineering and Wallgate Limited's liability for all damages and losses (including negligence) shall not in any circumstances exceed the amount paid by the customer for the unit.

Galvin Engineering and Wallgate reserves the right to alter, update or improve its product specification at any time without prior notice. This manual is specific to the product that it has been supplied with at the date of supply.

Without prejudice to any warranties in Galvin Engineering and Wallgate Limited's terms and conditions of sale, any warranty will be invalidated if the equipment is installed or serviced by unqualified personnel.

No part of this publication and the information contained may be reproduced, transmitted, stored in a retrieval system, used or disclosed wholly or partly without prior written permission from Galvin Engineering and Wallgate Limited.

For full warranty details please see Galvin Engineering Wallgate Limited Terms and Conditions.

Please ensure this manual is passed to the end user. The manual forms an integral part of the product and should be kept for its working life. Additional copies of this and other supporting documents are available by contacting Wallgate Ltd or by visiting www.wallgate.com

2. Technical Specifications

Weight (kg)	50
Dimensions	Refer to CWC model drawing supplied separate to these instructions
Water Supply	Refer to the applicable product manual for the WC flush device
Soil pipe connection (mm)	105/108mm (external diameter) male spigot
Flush pipe inlet	55mm internal diameter female for 1.5" size pipe & pipe seal. (as supplied with flushing device)
Flushing device flow requirements	Cistern flush: 1.85 – 2 Litres per second. Direct flush: 1.5 Litres per second (nominally). Refer to flushing device product information for full details.



3. Optional Control Unit Specifications

Power supply	230V AC 50/60Hz 2 Amp single phase USA / CANADA: 120V AC 2Amp, 60Hz for models WDCA100 and WDCA200.
Power rating (W)	Maximum power rating 60
Weight (kg)	1.0
Dimensions (mm)	200 (W) x 150 (H) x 80 (D)
Enclosure IP Rating	IP53
Regulatory compliance	Complies with RoHS, LVD 2006/95/EC and EMC 2004/108/EC directives.

4. Conventions

Certain conventions are used in this manual to make it easier to read and understand. They are given in the sections below.

4.1. Warning

A warning with white text on a red background is used to give information about hazards that can cause injury or death. Read and understand these warnings before you install and commission the CWC water closet. Failure to heed these warnings can have serious consequences.

WARNING!

This is a warning!

4.2. Note

A note with black text on a yellow background is used to draw your attention to important and useful information.

NOTE

This is a note.

4.3. Numbered procedures

Steps in procedures are numbered, starting from 1.

1. This is step 1.
 2. This is step 2 etc.
- 2.4 Bullet lists

4.4. Bullet lists

- A bullet list is used to give information that is not sequential.

4.5. Menu items

Menu items, submenu items and settings, where available, are given in bold.



5. Installation

5.1. Package Contents

Before you begin the installation, make sure that you have the following items:

- Product Manual
- CWC Water Closet
- Wall and Floor Fixings
- Required tools

Tooling Required

- Hammer Drill
- Impact Driver
- Ratchet
- 6mm Carbide Drill Bit (Floor Fixing)
- 6.5mm High Speed Drill Bit (Side Fixing)
- Torx 30 Driver Head (Floor Fixing & Side Fixing)

Each wall fixing kit includes

- Zinc Plated Angled Brackets x2
- Floor Fixing Screws x4
 - TORX DRIVE BUTTON HEAD SCREWBOLT GALVANISED (GEO) 7.8 x 60mm
- Side Fixing Screws x2
 - RESYTORK PAN HEAD SELF DRILLER 410 STAINLESS STEEL 14G x 2"
- Side Fixing Washers x2
 - M6 x 12.5 x 1.2mm G304 STAINLESS STEEL FLAT WASHER

NOTE: An electronic control unit & flushing device (i.e. Cistern & flush valve) with cables are supplied separately as an option. Various control options are available, contact the Wallgate sales desk for more information.

5.2. Site Preparation

Mounting Guidelines

- The CWC is a back to wall type pan for installations, however, with no access to the rear of the pan installation, the following mounting guidelines provide the most reliable installation without through the wall fixings.
- The CWC is suitable for various types of flushing device that Wallgate can provide & have been tested, to ensure compliance & compatibility with the WC pans. The flushing device is to provide a max full flush volume of 6 litres. If a dual flush is required, then the reduced flush volume is to be 4 litres max. Where the flushing device is a cistern with flush valve, then the cistern should be a low level mounted type. Refer to section 6 for additional technical information. The WC pans are not compatible for use with close coupled cisterns.
- Suitable cisterns & alternative operating push buttons, sensors & flush valves are available from Wallgate.
- An electrical supply of 230V 50Hz with a 2 Amp rating is required for the optional electronic control units.
- A 110mm Ø soil pipe should be provided for connection to the CWC. The soil pipe can be connected to the tail on the CWC using a suitable connector.

- A mains cold water supply should be provided and terminated with a suitable isolating tap for connection to the flushing device. Refer to the product instructions of the flushing device for details of connection sizes and water supply ratings for pressure & flow.
- Apertures or holes are required in the wall for the flush pipe to the WC pan. Details of their position are shown on the relevant drawing provided with the pan model type.

5.3. Preparing & fitting the Water Closet

WARNING!

The CWC Water Closets weigh more than 25Kg so a two-man lift is recommended. Always use safe lifting procedures when lifting heavy loads. For large installations of several water closets, an optional lifting hook is available from Wallgate.

WARNING!

To maintain the anti-ligature & anti-vandal properties of this product it must be installed in line with the following points.

1. Ensure product fixings are correctly fitted as detailed in the following instructions.
2. Ensure all fixings are tightened to the recommended torque as detailed in the following instructions.
3. Seal the edges of the product to the wall using anti-pick hard set mastic, examples of recommended types are:

Arbokol 1025, manufactured by Adshead Ratcliffe & Co Ltd (www.arbo.co.uk).

Sikadur 33 manufactured by Sika Ltd (www.sika.co.uk)

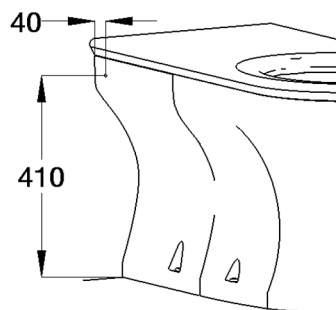

1. Remove the CWC from its packaging and place carefully onto a protective sheet on the floor such as cardboard to avoid damage to the base edges. Under no circumstances should the CWC be knocked or dropped when placing onto the floor as damage to the bottom rim edges may result.
2. Drill Pilot Holes for Side Fixings
The position of the pilot holes needs to be 410 mm from the bottom (floor) and 40mm from the back of the pan on each side as shown above.

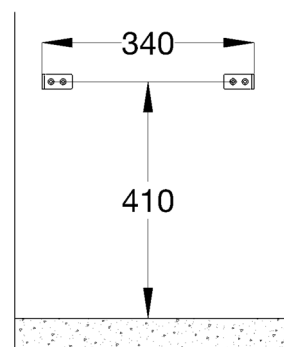

3. Fix Brackets to the Wall
 - The position of the brackets needs to be 340 mm apart (outside edge to outside edge), and 410 mm from the floor to the centre of the bracket.
 - Fix the brackets to the wall with the appropriate pilot holes/screws for the wall material, ensuring 2 screws per bracket.

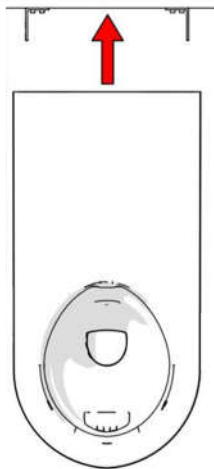

4. Slide the pan onto the wall, taking care to make sure the inside edges of the pan are straddling the brackets.

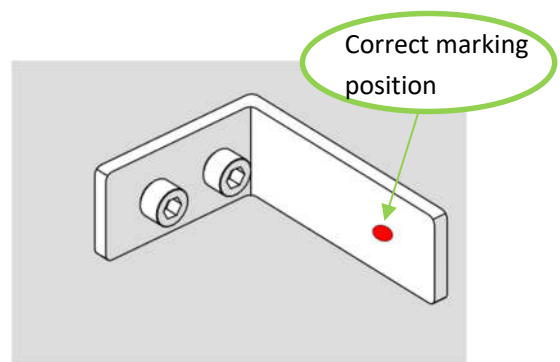

5. Test the position of the brackets by marking them with a drill bit through the pre-drilled pilot holes. The marks should be in the centre of the bracket (top to bottom).

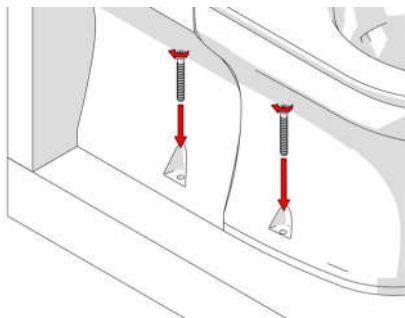

6. Floor Fixing
- With the pan in position against the wall, use a pencil to mark out the 4 pilot hole positions for drilling.
 - Using a hammer drill with 6mm Carbide Drill Bit, drill the four holes to at least 60mm depth to accommodate the floor fixing screws.
 - Slide the pan back into position and test that the holes line up.
 - Using a ratchet with Torx T30 Driver Head, tighten each screw to 6 Nm.

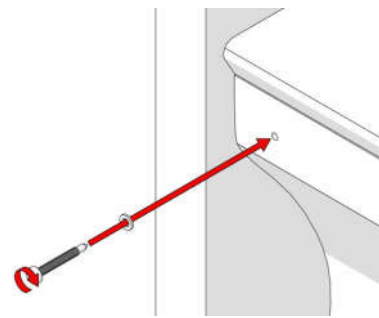

7. Side Fixing
- Using an impact driver with Torx T30 Driver Head, blind drill the SS Resytork Screws (with SS Washer attached) into the brackets to 12 Nm. See Figure 6.

NOTE

Do not drill into the floor through the holes in the WC pan or extension as there is a risk that it may result in damage to the products.



8. Fit the flush pipe seal provided with the flushing device into the top hole on the back of the WC pan.
9. Locate the CWC outlet spigot into the soil pipe connector and position the WC into place (with the extension if applicable).
10. Check that the back of the WC pan has fitted to the wall without any gaps due to an uneven wall finish prior to tightening side fixings to a torque of 12Nm and floor fixings to a torque of 6Nm. Gradually tighten all fixing Screws evenly in a rotational method so each one gradually tightens to the stated torque.
11. Tighten the floor fixings (if used) ensuring that they are not overtightened as that may result in damage to the pan, the recommended max torque is 6Nm. It is vital that the floor surface is level as an uneven floor surface may also result in damage to the pan when the fixings are tightened. Fit the floor fixing screw covers.

WARNING!

Fitting the water closet to an uneven floor surface or overtightening the floor fixings may result in damage to the product.

12. Apply an anti-pick, hard set mastic, such as Arbokol 1025 or Sikadur 33 around the back and bottom edges of the pan (& extension if appropriate) to seal it to the wall & floor.
13. Install the flushing device in accordance with the instructions provided with it. Note that for a cistern type device it must be mounted at the correct height to its base from floor level as shown on the installation drawing provided to ensure the flush performance is not impaired.
14. An external overflow pipe for a cistern type flushing device may be required if the flush valve type being used does not provide internal overflow into the WC pan.

6. Commissioning

To commission the CWC Water Closet:

1. Turn ON the water supply & check all around for leaks on the flushing device & the pan water inlet & outlet connectors.
2. Depending upon which type of flushing device has been fitted; you will need to refer to the instructions provided with it to ensure it is set correctly to give the correct operation & performance.
3. Operate the flush and check that the toilet flush's satisfactorily.
4. Check again for any leaks as detailed in (a) above.
5. Ensure that on completion these instructions & those for the flushing device & associated controls are passed onto the customer.



7. User and Maintenance Instructions

7.1. Operation

The CWC can be used in conjunction with various types of flushing devices and/or controls. Refer to the instructions provided with those products for full details regarding operation & set up.

7.2. Maintenance

- The CWC is manufactured from a cast solid surface composite that is very durable. A planned on-going care & maintenance routine will ensure that the product will last for many years.
- Refer to the “Care & Maintenance Instructions Leaflet” available from Wallgate (www.wallgate.com).
- Further advice on this & other Wallgate products may be obtained by contacting the “Wallgate Sales or Service Offices”.

